

SANITARY FITTINGS
IN STAINLESS STEEL
COMPLETE RANGE



WAGNER
— **EWAR**



STYLE

IS WHAT GIVES VALUE AND
CURRENCY TO THOUGHTS

ARTHUR SCHOPENHAUER

The safe grip
Barrier-free living

P. 7



Models for surface mounting
A-Line

P. 11



Models for surface mounting
L-Line

P. 30



Models for surface mounting
P-Line

P. 33



Accessories

P. 39



Fittings and
tabletop soap dispensers

P. 47



Models for flush-mounting

P. 51



Models for under-counter
mounting

P. 63



Consumables

P. 71

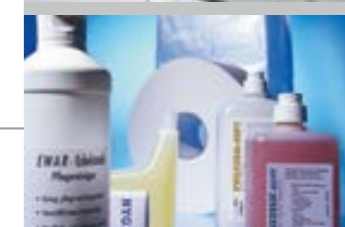



Wagner-EWAR – Our standards

Being close to the market and reacting fast are prerequisites for success. Our in-house production ensures that we can offer this flexibility. This enables us to guarantee a high level of quality and to keep delivery times extremely short.

Our experienced employees come to offer these stalwart advantages of working for us, which through their excellent technical understanding and continuous training, ensure that we are always one step ahead. It also means that our products are often considered the precursors of innovative solutions.

In any case, from the planning stage to implementation, you will always have an authoritative and dedicated partner at your side.

Wagner-EWAR – Our material

Stainless steel, as its name suggests, is a high-grade material. On the one hand it excels through its durability and robustness and on the other hand through its timeless appearance.

The stainless steel, has been exclusively processed by us, material number AISI 304, also known as chrome nickel steel 18/10, also boasts the enjoyable property of absorbing light and colours from the environment and reflecting them back again. This means that stainless steel devices can be easily integrated into almost every room where they also set standards.

Stainless steel, unlike most other materials, meets the increasingly stringent hygiene requirements: The surfaces feature durable mechanical and chemical resistance and can be easily and efficiently cleaned.

This makes stainless steel the ideal combination of longevity, functionality and stylish aesthetics in satin or polished finishes.



Wagner- EWAR – Our sanitary equipment programme

The programme captivates us with its carefully considered complement of design and functionality. The quality of our products convinces users right down to the last detail.

Continuous improvements to products and exact processing guarantee the utmost hygiene: easily accessible corners, welded edges and simultaneously avoiding unnecessary attached parts and notches provide you with the necessary security.

Even in day-to-day work our devices can be easily and quickly cleaned, easily filled or emptied. Last but not least, stainless steel ensures that the pleasure you gain from Wagner-EWAR products will be long-lasting.



Wagner-EWAR – Our clients

Our work is tailored to the requests, ideas and visions of architects, planners and interior designers and therefore also to those of their clients and contractors.

We advise and inform about the different designs, combination options and installation variations in public and commercial buildings such as airports, exhibition halls, schools and universities, hotels and restaurants, banks and insurance companies, council buildings and local authorities and sports centres etc.

“The secure handle” programme for barrier-free living also offers applications for clinics, care centres and in the wellness field.

We meet our clients’ high standards where quality, functionality and design are concerned.



THE SAFE GRIP BARRIER-FREE LIVING



Grab handles, support rails, shower curtain rails, seats

- satin finish, grab handles and support handles also available with structured surface
- handles and seats have been TÜV/GS tested and CE designated



Contents (no image)

BA 260 Corner basket

220 x 47 x 160 mm

- brass, chrome-plated

BA 270 Straight basket

265 x 87 x 123 mm

- brass, chrome-plated

BA 044 Shower curtain ring

- grey plastic

BA 030 Showerhead holder

- brass, chrome-plated
- continuously adjustable

BA 300



BA 300 Adjustable mirror

600 x 540 x 90 mm

- in stainless steel highly polished
- tilt angle continuously adjustable

* adheres to Austrian Ö-Norm standard, B 1600 and B 160001

** can also be manufactured in adherence to the Ö-Norm in size 1,000 x 1,000 mm

BF 680



BF 680 Corner shower curtain rail with adjustable ceiling overhang

900 x 900 mm

1000 x 1,000 mm

1200 x 1,200 mm

1500 x 1,500 mm

1000 x 1,200 mm

1000 x 1,500 mm



BF 600



BF 600 Grab handle

300 mm
400 mm
500 mm
600 mm
1,000 mm

BF 620



BF 620 Angled grab rail with shower riser

left or right (see photo) version
1100 x 600 mm left
1100 x 600 mm right

BF 601



BF 601 Shower rail with shower riser

600 mm
800 mm
1,000 mm
1,100 mm

BF 690



BF 690 Straight shower curtain rail

900 mm
1,000 mm
1,200 mm
1,500 mm

BF 640

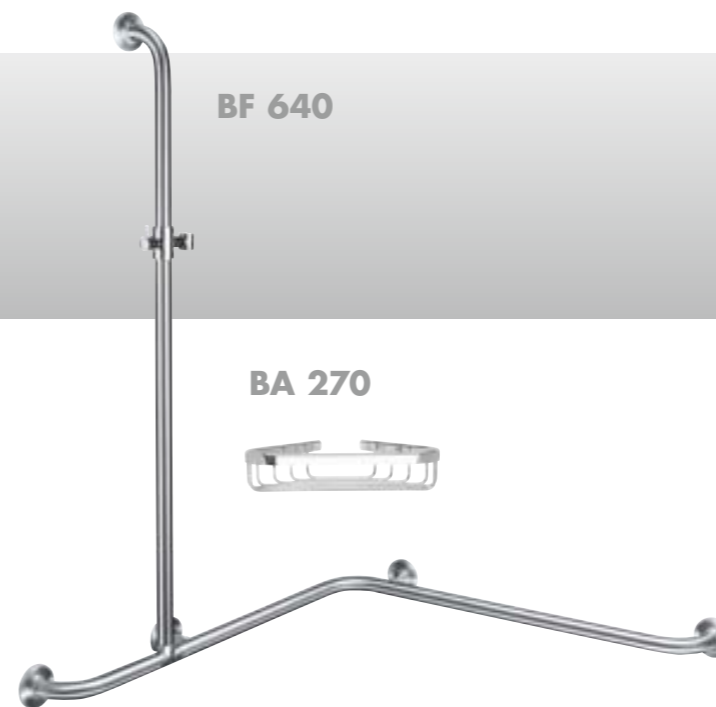

BF 650 Shower grab rail

(no image)
700 x 700 mm
800 x 800 mm
900 x 900 mm

BF 660 Wall-floor support rail

(no image)
850 x 850 mm right
900 x 900 mm right
850 x 850 mm left
900 x 900 mm left

BF 640 Shower grab rail with shower riser

shower rail 1,150 mm

left (see photo) or right version

700 x 700 x 1,150 mm left*
800 x 800 x 1,150 mm left
800 x 800 x 1,150 mm right
900 x 900 x 1,150 mm left
900 x 900 x 1,150 mm right

BA 250



BA 250 Backrest for toilet seat

575 x 180 x 140 mm

- with black surface, removable
- incl. 500 mm rail

BA 200 Removable folding seat

430 x 470 x 580 mm

- for hooking into Wagner-EWAR shower grab rails or angled grab rails
- brass, chrome-plated overhang
- maximum 130 kg load

BA 220



BA 220 Fixed backrest for folding seat

380 x 180 x 30 mm

- with black surface
- removable for cleaning

BA 210



BA 210 Fixed folding seat

460 x 180 x 435 mm

- for wall mounting
- brass, chrome-plated overhang
- maximum 130 kg load

BF 630



BF 630 Angled grab rail 135°
700 mm

Right (see photo) or left versions

BF 630



BF 630 Angled grab rail 45°
500 mm

Right (see photo) or left versions

BF 620



BF 620 Angled grab rail 90°
650 x 350 mm or
750 x 400 mm

Left version (see photo) or right

BF 670

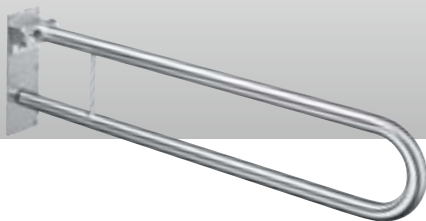

BF 670 Hinged support rail

600 mm long
700 mm long
850 mm long*
* adheres to Austrian
Ö-Norm standard, B 1600
and B 160001

Wall plate 90 x 250 mm

BF 611

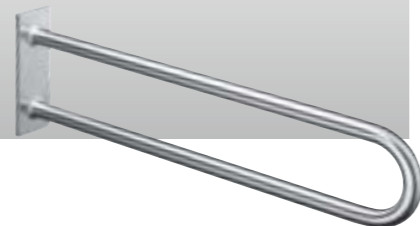

BF 611 Support rail

500 mm long
600 mm long
700 mm long
850 mm long

Wall plate 90 x 250 mm with
concealed fixings

Contents (no image)

BA 010 Toilet roll holder

130 mm x 100 mm

- welded in position for support handles
- secured against random unrolling

BA 020 Flush and call device

68 x 108 x 71 mm

- for assembly on support handle
- compatible with 868.4 Mhz flush systems

BA 063 Flush device for large and small
volume of water

68 x 108 x 71 mm

- for assembly on support handle
- compatible with 868.4 Mhz flush systems

BA 017 Pre-installed fixing plate
with cover

90 x 250 x 6 mm

- for retrofitting a support rail or
hinged support rail

All handles tested according to
DIN 12182 by:



MODELS FOR SURFACE MOUNTING

A-LINE

L-LINE



A-Line Soap dispensers

- available in satin and polished finishes
- hinged for refilling
- single-handed operation, drip-free soap pump

WP 101
WP 101-1



WP 101 Liquid soap dispenser
70 x 270 x 110 mm

- capacity: 500 ml soap bottle
- lockable

WP 101-1 Liquid soap dispenser
70 x 270 x 120 mm

- capacity: 700 ml soap with fixed soap tank
- lockable

WP 102
WP 102-1



WP 102 Liquid soap dispenser
80 x 298 x 120 mm

- capacity: 950 ml soap bottle
- lockable

WP 102-1 Liquid soap dispenser
80 x 298 x 120 mm

- capacity: 1100 ml soap with fixed soap tank
- lockable

WP 101e



Sensor-liquid soap dispenser
90 x 257 x 120 mm

- capacity: 500 ml soap bottle
- lockable

WP 102e



Sensor-Liquid soap dispenser
90 x 298 x 120 mm

- capacity: 950 ml soap bottle
- lockable

WP 103



Foam soap dispenser
80 x 298 x 120 mm

- capacity: 400-ml bottle soapconcentrated lather
- lockable

WP 105



Liquid soap dispenser
148 x 148 x 120 mm

- capacity: 1000-ml soap with fixed soap tank
- lockable

WP 107



Liquid soap dispenser
70 x 170 x 90 mm

- capacity: 200-ml soap with fixed soap tank
- lockable

WP 120



Disinfectant dispenser
80 x 245 x 220 mm

- for a 500 ml disinfectant-bottle
- image without accessories: receptacle for WP 120, cover plate in stainless steel lockable WP 120

WP 121



Disinfectant dispenser
92 x 290 x 225 mm

- for a 1000 ml disinfectant-bottle
- image with accessories: receptacle for WP 121, cover plate in stainless steel lockable WP 121

A-Line disinfectant dispenser

- half open housing made out of stainless steel, satin finished
- universal usage
- elbow operation, bracket distance 225 mm
- adjustable pump

A-Line
Paper towel dispensers

- available in satin and polished finishes
- lockable
- devices hinged for refilling

WP 111



Paper towel dispenser
 298 x 448 x 120 mm

- capacity: approx. 750 paper towels
- lockable

WP 113



Paper towel dispenser
 298 x 298 x 120 mm

- capacity: approx. 500 paper towels
- lockable

A-Line
Hot air hand dryer, electronic touch-free paper roll dispensers

- satin finished with tapered glossy surface I.I.D. at the bottom



WP 1100



WP 1300
WP 1301



WP 1400
WP 1401



Hot air hand dryer
 298 x 396 x 150 mm

- contact-free, HF radar sensor technology
- low noise development
- drying time 30 s factory setting
- power rating 2000 W

Electronic touch-free paper roll dispenser
 350 x 448 x 210 mm

350 x 448 x 210 mm

- capacity: 1 paper roll
- contact-free, capacitive sensor technology
- residual roll function
- paper length and idle time adjustable

WP 1300 transformer-operated
WP 1301 battery-operated

Electronic touch-free paper roll dispenser
 350 x 580 x 210 mm

350 x 580 x 210 mm

- capacity: 1 paper roll + 1 reserve roll
- contact-free, capacitive sensor technology
- residual roll function
- paper length and idle time adjustable

WP 1400 transformer-operated
WP 1401 battery-operated

WP 118



Tissue dispenser for Kleenex® boxes
 269 x 122.5 x 76 mm

- for 1 Kleenex® box



A-Line
Waste bins and
sanitary waste bins,
waste baskets

WP 133



Waste bin
298 x 598 x 140 mm

- capacity: approx. 12 litres
- with mesh basket
- with hinged lid
- lockable

WP 131



Waste bin
448 x 598 x 120 mm

- capacity: approx. 16 litres
- with mesh basket
- with hinged lid
- lockable

WP 126



Waste bin
298 x 448 x 170 mm

- capacity: approx. 23 litres
- with fabric standbag

WP 152



Waste bin
298 x 598 x 190 mm

- capacity: approx. 34 litres
- with fabric standbag

WP 183



Waste bin
400 x 600 x 250 mm

- capacity: approx. 60 litres
- with fabric standbag
- with 4 rubber feet

WP 151
WP 151-1
WP 151-2

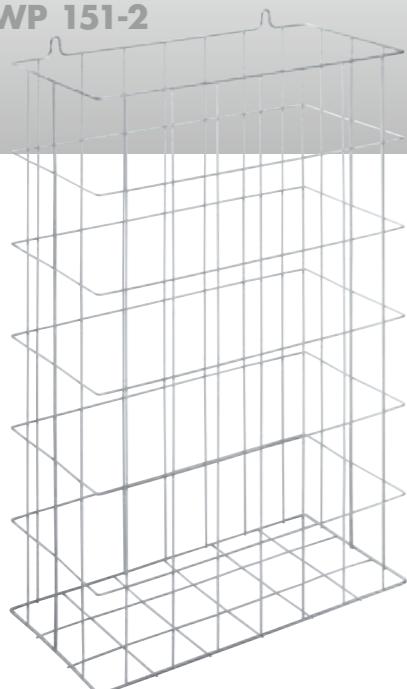

Waste basket
400 x 600 x 200 mm

- capacity: approx. 48 litres

WP 151, chrome-plated
WP 151-1, stainless steel
WP 151-2, plastic powder coating

WP 150
WP 150-1
WP 150-2

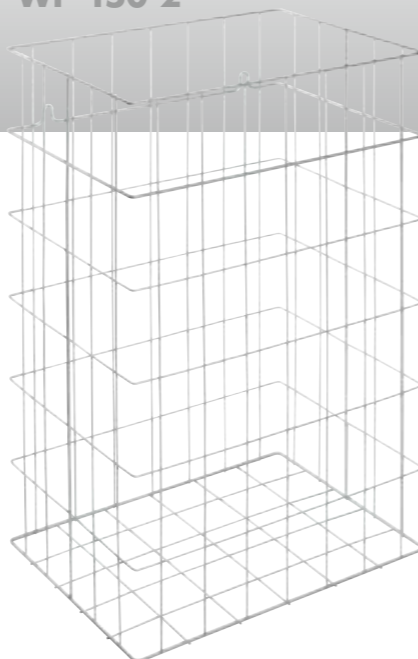

Waste basket
400 x 600 x 300 mm

- capacity: approx. 72 litres

WP 150, chrome-plated
WP 150-1, stainless steel
WP 150-2, plastic powder coating

WP 180



Waste bin
298 x 598 x 308 mm

- capacity: approx. 36 litres
- with removable mesh basket
- with 2 hinged flaps
- with 4 rubber feet
- lockable

WP 181



Waste bin
298 x 598 x 308 mm

- capacity: approx. 36 litres
- with removable mesh basket
- open at top
- with 4 rubber feet
- lockable



**A-Line
Sanitary waste bins**

- available in satin and polished finishes
- with plastic hygiene insert

WP 177



Hygiene waste bin
220 x 250 x 115 mm

- with sanitary bag dispenser, on the side
- capacity: approx. 5 litres
- with hinged lid

WP 179



Hygiene waste bin
200 x 250 x 115 mm

- capacity: approx. 5 litres
- with hinged lid

WP 137



Hygiene waste bin
298 x 448 x 120 mm

- with dispenser for paper sanitary bags
- capacity: approx. 5 litres
- with hinged lid
- lockable

WP 177-1



Hygiene waste bin
220 x 344 x 115 mm

- insertion sluice as visual cover
- with sanitary bag dispenser, on the side
- capacity: approx. 5 litres
- with hinged lid

WP 179-1



Hygiene waste bin
200 x 344 x 115 mm

- insertion sluice as visual cover
- capacity: approx. 5 litres
- with hinged lid

WP 177-2



Hygiene waste bin
300 x 398 x 155 mm

- with sanitary bag dispenser, on the side
- capacity: approx. 12 litres
- with hinged lid

WP 179-2



Hygiene waste bin
300 x 398 x 155 mm

- capacity: approx. 12 litres
- with hinged lid

**A-Linie
Nappy changer**

- available in satin finish
- available in horizontal and vertical versions
- table surface molded made of grey Polypropylen
- easy to open and to close with assistance from a maintenance free, pneumatic cylinder
- TÜV-certified



WP 601-604



Stainless steel mirror

WP 601 Dimensions 600 x 600 mm
 WP 602 Dimensions 600 x 400 mm
 WP 603 Dimensions 800 x 400 mm
 WP 604 Dimensions 700 x 500 mm

- highly polished stainless steel mirror

WP 2015



Nappy changer
910 x 576 x 135 mm

WP 2115



Nappy changer
540 x 946 x 135 mm

**WP 550
WP 550e
WP 550-5**



Combination paper towel and soap dispenser
400 x 298 x 120 mm

- capacity: approx. 500 paper towels
- capacity: WP 550: 500 ml soap bottle
 WP 550e: Sensor-soap dispenser with 500 ml soap bottle
 WP 550-5: 400 ml foam soap concentrate
- lockable

**WP 600
WP 600e
WP 600-5**



Mirror cupboard
450 x 450 x 130 mm

- cut glass mirror – to be handled as a door
- with built-in paper towel and soap dispenser
- capacity: approx. 500 paper towels
- capacity: WP 600: 950 ml soap bottle
 WP 600e: Sensor-soap dispenser with 950 ml soap bottle
 WP600-5: 400 ml foam soap concentrate
- lockable

Contents: Lighting set (no image)

**WP 650
WP 650e
WP 650-5**



Mirror cupboard
600 x 600 x 130 mm

- cut glass mirror – to be handled as a door
- with built-in paper towel and soap dispenser
- capacity: approx. 750 paper towels
- capacity: WP 650: 950 ml soap bottle
 WP 650e: Sensor-soap dispenser with 950 ml soap bottle
 WP 650-5: 400 ml foam soap concentrate
- lockable

Contents: lighting set (no image)



WP 535

WP 545

WP 510
WP 510e
WP 510-1
WP 510-5

**A-Line
Combinations**

- available in satin and polished finishes
- dispensers hinged for refilling
- waste bins with mesh basket
capacity: 11 litres
- with hinged lid
- lockable



Combination paper towel dispenser and waste bin
298 x 898 x 120 mm

- capacity: approx. 250 paper towels



Combination paper towel dispenser and waste bin
298 x 1048 x 120 mm

- capacity: approx. 500 paper towels



Combination paper towel dispenser, soap dispenser and waste bin
298 x 1348 x 120 mm

- capacity: approx. 250 paper towels
- capacity:
 - WP 510: 950 ml soap bottle
 - WP 510e: Sensor-soap dispenser with 950 ml soap bottle
 - WP 510-1: 1100 ml fixed soap tank
 - WP 510-5: 400 ml foam soap concentrate



A-Line Combinations

- available in satin and polished finishes
- dispensers hinged for refilling
- waste bins with mesh basket
- capacity: 32 litres
- waste deposited from top
- lockable



WP 5015



**Combination paper towel
dispenser and waste bin**
298 x 1048 x 220 mm

- capacity: approx.
250 paper towels
- capacity: 32 litres

WP 5115



**Combination paper towel
dispenser and waste bin**
298 x 1198 x 220 mm

- capacity: approx.
500 paper towels
- capacity: 32 litres

WP 5125



**Combination paper towel
dispenser and waste bin**
298 x 1198 x 220 mm

- capacity: approx.
500 paper towels
- capacity: 32 litres

WP 5415



WP 5425



WP 5455



WP 5715



WP 5725



Combination paper towel, soap dispenser and waste bin*
448 x 1198 x 220 mm

- capacity: approx. 500 paper towels
- soap dispenser with single-handed, drip-free soap pump
- capacity: 950 ml soap bottle
- with mesh basket, capacity: approx. 48 litres

Combination paper towel, soap dispenser and waste bin*
448 x 1198 x 220 mm

- capacity: approx. 500 paper towels
- soap dispenser with single-handed, drip-free soap pump
- capacity: 950 ml soap bottle
- with mesh basket, capacity: approx. 48 litres

Combination electronic touch-free paper roll dispenser and waste bin
448 x 1348 x 220 mm

- capacity: 1 paper roll
- contact-free, capacitive sensor technology
- residual roll function
- paper length and idle time adjustable
- with mesh basket, capacity: approx. 48 litres

Combination paper towel dispenser, soap dispenser and waste bin*
448 x 1348 x 320 mm

- capacity: approx. 750 paper towels
- soap dispenser with single-handed, drip-free soap pump
- capacity: 950 ml soap bottle
- with mesh basket, capacity: approx. 72 litres

Combination paper towel dispenser, soap dispenser and waste bin*
448 x 1348 x 320 mm

- capacity: approx. 750 paper towels
- soap dispenser with single-handed, drip-free soap pump
- capacity: 950 ml soap bottle
- with mesh basket, capacity: approx. 72 litres

* Also available upon request with sensor-liquid soap dispenser or foam soap dispenser

**A-Line
WC products**

WP 163



Large roll dispenser
353 x 350 x 120 mm

- for 1 large roll
- secured against random unrolling
- hinged for refilling
- lockable

WP 163-S



Toilet roll holder
353 x 350 x 120 mm

- for 4 toilet rolls
- replacement rolls automatically drop down
- hinged for refilling
- lockable

WP 164



Toilet roll holder
148 x 348 x 150 mm

- for 2 toilet rolls
- replacement roll automatically drops down
- hinged for refilling
- lockable

WP 169



Toilet paper sheet dispenser
120 x 298 x 120 mm

- capacity: 2 x 250 single sheets
- hinged for refilling
- lockable

WP 162



Toilet brush set
148 x 448 x 120 mm

- full metal housing with stainless steel cup and handle on the inside of the door

WP 168



Toilet roll storage dispenser
120 x 680 x 130 mm

- for 5 toilet rolls
- replacement rolls automatically drop down
- open at the top

WP 148



Toilet roll holder
140 x 110 x 90 mm

- for 1 toilet roll
- lockable

WP 149



Double toilet roll holder
240 x 110 x 90 mm

- for 2 toilet rolls
- lockable



WP 119



Wet wipe toilet paper dispenser
172 x 79 x 135 mm

- for 1 customary wet wipe toilet paper box
- with hinged lid

**WP 156
WP 156-1**



Sanitary bag dispenser
100 x 130 x 25 mm

- for 1 hygiene bag box
- hinged for refilling

WP 156-1 Sanitary bag dispenser (no image)
100 x 170 x 25 mm

- for 1 hygiene bag box
- hinged for refilling
- lockable

WP 155

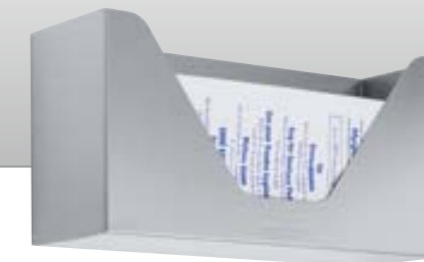

Sanitary bag storage container
298 x 148 x 100 mm

- for paper sanitary bags



L-Line
Soap dispensers,
paper towel dispensers,
waste bins

- full metal housing of stainless steel, satin finished
- conical front with vertical deep curve
- quadratic opening "full" indicator
- dispensers lockable and hinged for refilling



L 111



Paper towel dispenser
 298 x 448 x 130 mm

- capacity: approx. 750 paper towels



L 113



Paper towel dispenser
 298 x 298 x 130 mm

- capacity: approx. 500 paper towels

L 109



Liquid soap dispenser
 148 x 298 x 130 mm

- capacity: 950 ml soap bottle
- single-handed operation, drip-free soap pump

L 109e



Sensor-liquid soap dispenser
 148 x 298 x 130 mm

- capacity: 950 ml soap bottle
- drip-free soap pump

L 133



Waste bin
 298 x 598 x 140 mm

- capacity: approx. 12 litres
- with mesh basket
- lockable

L 187



Waste bin
 298 x 448 x 180 mm

- capacity: approx. 24 litres

L 185



Waste bin
 298 x 598 x 180 mm

- capacity: approx. 32 litres



L 186

L 184

L 182



Waste bin
298 x 448 x 180 mm

- capacity: approx. 24 litres

Waste bin
298 x 598 x 180 mm

- capacity: approx. 32 litres

Waste bin
298 x 598 x 197 mm

- capacity: approx. 30 litres
- rounded front

MODELS FOR SURFACE MOUNTING

P-LINE



**P-Line
Soap dispensers**

- full metal housing of stainless steel, satin finished
- housing with rounded vertical corners
- dispensers hinged for refilling

PP 101



Liquid soap dispenser
80 x 248 x 120 mm

- capacity: 700-ml soap with fixed soap tank
- lockable

PP 102



Liquid soap dispenser
80 x 298 x 120 mm

- capacity: 1100-ml soap with fixed soap tank
- lockable

PP 103



Foam soap dispenser
80 x 298 x 120 mm

- capacity: 400-ml bottle foam soap concentrate
- lockable

PP 17



Liquid soap dispenser
70 x 172 x 90 mm

- capacity: 200-ml soap with fixed soap tank

PP 107



Liquid soap dispenser
70 x 172 x 90 mm

- capacity: 200-ml soap with fixed soap tank
- lockable

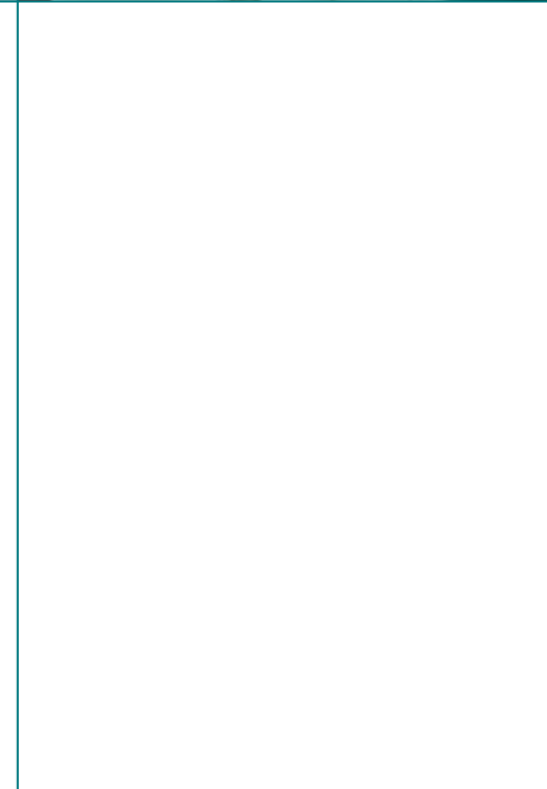

**P-Line
Waste bins**

- full metal housing of stainless steel, satin finished
- housing with rounded vertical corners

PP 151



Waste basket
400 x 600 x 250 mm

- capacity: approx. 60 litres
- with fabric standbag

PP 111



Paper towel dispenser
265 x 448 x 120 mm

- capacity: approx. 750 paper towels
- lockable

PP 113



Paper towel dispenser
265 x 298 x 120 mm

- capacity: approx. 500 paper towels
- lockable

PP 108



Paper towel dispenser
265 x 175 x 120 mm

- capacity: approx. 250 paper towels
- lockable

PP 126



Waste bin
298 x 448 x 170 mm

- capacity: approx. 23 litres
- with fabric standbag

PP 152



Waste bin
298 x 598 x 190 mm

- capacity: approx. 34 litres
- with fabric standbag

PP 182



Waste bin
298 x 598 x 250 mm

- capacity: approx. 45 litres
- with fabric standbag

PP 115



Paper towel dispenser
230 x 298 x 90 mm

- capacity: approx. 500 narrowly folded (max. 85 mm) paper towels
- lockable

PP 13



Paper towel dispenser
298 x 298 x 120 mm

- capacity: approx. 500 paper towels
- open at the top

**P-Line
Paper towel dispensers**

- full metal housing of stainless steel, satin finished
- housing with rounded vertical corners
- dispensers hinged for refilling

P-Line Accessories

- made of stainless steel solid turned

PC 222



PC 215



Reserve paper roll holder
diameter 45 x 80 mm

- for 1 toilet roll

Mini hook
diameter 45 x 36 mm

PC 250



Toilet roll holder
144 x 107 x 36 mm

- for 1 toilet roll
- L-shaped

PC 261



Toilet brush set
110 x 410 x 115 mm

- with stainless steel handle and
exchangeable brush head
- cup made of Polypropylene
- front panel with rounded horizontal
corners



ACCESSORIES



Accessories

- made of stainless steel solid turned
- available in satin and highly polished finishes
- theft-deterrent wall-mounting

AC 250



Toilet roll holder
135 x 110 x 66 mm

- for 1 toilet roll
- L-shaped

AC 252



Double toilet roll holder
260 x 110 x 66 mm

- for 2 toilet rolls
- L-shaped

AC 220



Toilet roll holder
150 x 92 x 40 mm

- for 1 toilet roll
- U-shaped

AC 221



Toilet brush set
97 x 430 x 129 mm

- with stainless steel handle and exchangeable brush head
- with top overhang
- cup height 130 mm

AC 261



Toilet brush set
97 x 380 x 129 mm

- with stainless steel handle and exchangeable brush head
- cup height 130 mm

AC 211



Ashtray
125 x 89 x 45 mm

- tray diameter 89 mm





AC 214

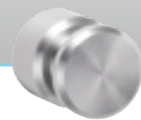

Mini hook
diameter 16 x 22 mm

AC 215



Single hook
diameter 45 x 36 mm

AC 216



Double hook
diameter 45 x 45 mm

AC 270



Soap shell
125 x 89 x 45 mm

- tray diameter 89 mm

Accessories

- made of stainless steel solid turned
- available in satin and highly polished finishes
- theft-deterrent wall-mounting



AC 222



Reserve paper roll holder
diameter 40 x 80 mm

- for 1 toilet roll

AC 225-2



Double reserve toilet roll holder
diameter 40 x 233 x 110 mm

- for 2 toilet rolls

AC 225-3

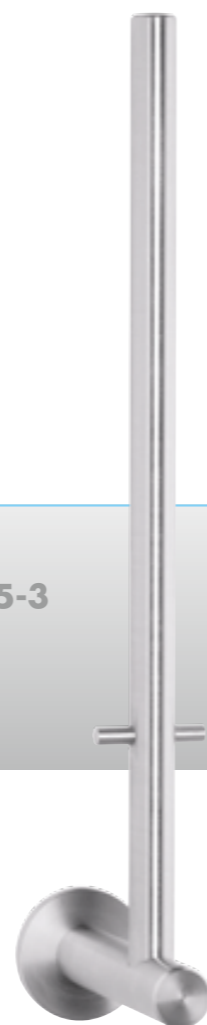

Triple reserve toilet roll holder
diameter 45 x 333 x 110 mm

- for 3 toilet rolls

AC 230-232



Towel Rail

AC 230 axis dimension for assembly 300 mm
AC 231 axis dimension for assembly 450 mm
AC 232 axis dimension for assembly 600 mm

Pictograms

- made of 2 mm stainless steel
- available in satin finishes
- for glueing or screwing
- basic format 120 x 120 mm



AC 460/461



AC 460 "First aid" pictogram,
for glueing

AC 461 "First aid" pictogram,
for screwing (no image)

AC 470/471



AC 470 "Cloakroom" pictogram,
for glueing

AC 471 "Cloakroom" pictogram,
for screwing (no image)

AC 494/495

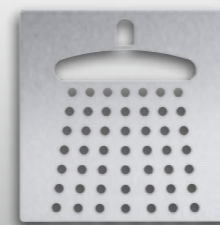

AC 494 "Shower" pictogram,
for glueing

AC 495 "Shower" pictogram,
for screwing (no image)

AC 490/491



AC 490 "Kitchen" pictogram,
for glueing

AC 491 "Kitchen" pictogram,
for screwing (no image)

Pictograms

- made of 0,8 mm stainless steel
- available in satin finishes
- for glueing
- basic format 70 x 30 mm

AC 425



AC 425 "Soap" pictogram

AC 426



AC 426 "Paper" pictogram

AC 400/401



AC 400 "Man" pictogram,
for glueing

AC 401 "Man" pictogram,
for screwing (no image)

AC 404/405



AC 404 "WC" pictogram,
for glueing

AC 405 "WC" pictogram,
for screwing (no image)

AC 410/411



AC 410 "Lady" pictogram,
for glueing

AC 411 "Lady" pictogram,
for screwing (no image)

AC 420/421



AC 420 "Child" pictogram,
for glueing

AC 421 "Child" pictogram,
for screwing (no image)

AC 422/423



AC 422 "Baby changing room"
pictogram,
for glueing

AC 423 "Baby changing room"
pictogram,
for screwing (no image)

AC 430/431



AC 430 "Barrier-free"
pictogram,
for glueing

AC 431 "Barrier-free"
pictogram,
for screwing (no image)

AC 440/441



AC 440 "No smoking"
pictogram,
for glueing

AC 441 "No smoking"
pictogram,
for screwing (no image)

AC 450/451



AC 450 "Smoking"
pictogram,
for glueing

AC 451 "Smoking"
pictogram,
for screwing (no image)

AC 217



Wall-mounted door buffer with hook
diameter 45 x 76 mm

AC 218



Wall-mounted door buffer
diameter 45 x 110 mm

AC 219



Wall-mounted door buffer
diameter 16 x 26 mm

AC 227



Floor door stop
diameter 40 x 40 mm

- with rubber ring

AC 228



Floor door stop
diameter 40 x 26 mm

- with rubber ring



FITTINGS AND TABLETOP SOAP DISPENSERS



Fittings and tabletop soap dispensers

- from solid turned stainless steel
- available in satin and highly polished finishes
- for building into vanity units
- combinable with many Wagner-EWAR models
- soap dispenser, top fillable
- single-handed operation, drip-free soap pump
- 500 ml soap bottle invisible under table

WA 100



Basin tap
diameter 45 x 170 x 155 mm

- design: Normal pressure
- overhang 120 mm
- upon request: 14 cm long lever

WA 110



Basin tap
diameter 45 x 283 x 155 mm

- design: Normal pressure
- overhang 120 mm
- upon request: 14 cm long lever

WA 200



Basin tap
diameter 45 x 170 x 155 mm

- design: Low pressure
- overhang 120 mm
- upon request: 14 cm long lever

WA 210



Basin tap
diameter 45 x 283 x 155 mm

- design: Low pressure
- overhang 120 mm
- upon request: 14 cm long lever



WP 195



Tabletop soap dispenser
diameter 30 x 130 x 120 mm

- overhang 90 mm

WP 195-10



Tabletop soap dispenser
diameter 30 x 276 x 120 mm

- overhang 90 mm

WP 191-3



Tabletop soap dispenser
diameter 38 x 62 x 115 mm

- overhang 90 mm

WP 192-3



Tabletop soap dispenser
diameter 38 x 208 x 160 mm

- overhang 130 mm

Tabletop soap dispensers

- brass, chrome-plated
- for building into vanity units
- combinable with many Wagner-EWAR models
- top fillable
- single-handed operation, drip-free soap pump
- 500 ml soap bottle invisible under table

WP 192-1



Tabletop soap dispenser
diameter 38 x 208 x 160 mm

- overhang 130 mm

WP 191-1



Tabletop soap dispenser
diameter 38 x 62 x 115 mm

- overhang 90 mm

WP 190



Tabletop soap dispenser
diameter 45 x 63 x 125 mm

- overhang 90 mm

WP 193



Tabletop soap dispenser
diameter 50 x 82 x 160 mm

- overhang 130 mm
- lockable



MODELS FOR FLUSH-MOUNTING



Models for flush-mounting
Paper towel dispensers,
soap dispensers,
hot air hand dryer,
WC products

- available in satin and polished finishes
- dispensers hinged for refilling
- soap dispensers with single-handed operation, drip-free soap pump
- lockable

WP 106



Liquid soap dispenser
 148 x 148 x 120 mm

- capacity: 1000-ml soap
- with fixed soap tank

WP 194



Panel mounted soap dispenser
 40 x 220 x 40 mm

- with suction tube to connect with soap tank on site

WP 167



Toilet roll holder
 148 x 348 x 150 mm

- for 2 toilet rolls
- replacement roll automatically drops down
- hinged for refilling
- lockable

WP 157



Toilet roll holder
 163 x 170 x 100 mm

- for 1 toilet roll
- with integrated mounting frame



WP 208
WP 208e



WP 208: Liquid soap dispenser
WP 208e: Sensor-liquid soap dispenser
 (no image)
 148 x 448 x 120 mm

- capacity: 950 ml soap bottle

WP 506



Electronic touch-free paper roll dispenser
 350 x 484 x 210 mm

- capacity: 1 paper roll
- contact-free, capacitive sensor technology
- residual roll function
- paper length and idle time adjustable

WP 1310 transformer-operated
WP 1311 battery-operated

WP 161



Toilet brush set
 148 x 448 x 120 mm

- full metal housing with stainless steel cup and handle on the inside of the door

WP 138



Hygiene waste bin
 298 x 598 x 120 mm

- with integrated dispenser for paper sanitary bags
- capacity: approx. 5 litres
- with plastic sanitary container
- with hinged lid

Models for flush-mounting
Paper towel dispensers,
soap dispensers,
hot air hand dryer,
WC products

- available in satin and polished finishes
- dispensers hinged for refilling
- soap dispensers with single-handed operation, drip-free soap pump
- lockable

WP 114



Paper towel dispenser
 298 x 298 x 120 mm

- capacity: approx. 250 paper towels

WP 112



Paper towel dispenser
 298 x 448 x 120 mm

- capacity: approx. 500 paper towels

WP 1200



Hot air hand dryer
 298 x 396 x 150 mm

- contact-free, HF radar sensor technology
- low noise development
- drying time 30 s factory setting
- power rating 2000 W

WP 147



Waste bin
 298 x 898 x 220 mm

- capacity: approx. 32 litres
- with mesh basket

WP 1310
WP 1311



Electronic touch-free paper roll dispenser
 350 x 484 x 210 mm

- capacity: 1 paper roll
- contact-free, capacitive sensor technology
- residual roll function
- paper length and idle time adjustable

WP 1310 transformer-operated
WP 1311 battery-operated

WP 1410
WP 1411



Electronic touch-free paper roll dispenser
 350 x 580 x 210 mm

- capacity: 1 paper roll + 1 reserve roll
- contact-free, capacitive sensor technology
- residual roll function
- paper length and idle time adjustable

WP 1410 transformer-operated
WP 1411 battery-operated

WP 134



Waste bin
 298 x 598 x 120 mm

- capacity: approx. 11 litres
- with mesh basket
- with hinged lid

Models for combinations

- available in satin and polished finishes
- lockable

WP 501



Combination paper towel dispenser and waste bin
298 x 645 x 164 mm

- capacity: approx. 250 paper towels
- waste bin with mesh basket
- capacity: approx. 11 litres
- with hinged lid

WP 530



Combination paper towel dispenser and waste bin
298 x 898 x 120 mm

- capacity: approx. 250 paper towels
- hinged for refilling
- with mesh basket, capacity: approx. 11 litres
- with hinged lid

WP 540



Combination paper towel dispenser and waste bin
298 x 1048 x 120 mm

- capacity: approx. 500 paper towels
- hinged for refilling
- with mesh basket, capacity: approx. 11 litres
- with hinged lid

**WP 500
WP 500e
WP 500-1
WP 500-5**



Combination paper towel dispenser, soap dispenser and waste bin
298 x 1348 x 120 mm

- dispenser hinged for refilling
- capacity: approx. 250 paper towels
- capacity:
 - WP 500: 950 ml soap bottle
 - WP 500e: Sensor-soap dispenser with 950 ml soap bottle
 - WP 500-1: 1100 ml fixed soap tank
 - WP 500-5: 400 ml foam soap concentrate
- with mesh basket, capacity: approx. 11 litres
- with hinged lid



WP 612



Combination paper towel dispenser and waste bin
298 x 748 x 140 mm

- for tile flush installation
- with continuous doors
- capacity: approx. 250 paper towels
- with mesh basket, capacity: approx. 7 litres
- waste deposited from top

WP 610



Combination paper towel dispenser and waste bin
298 x 1198 x 140 mm

- for tile flush installation
- with continuous doors
- capacity: approx. 750 paper towels
- with mesh basket, capacity: approx. 13 litres
- waste deposited from top

WP 5010



Combination paper towel dispenser and waste bin
298 x 1048 x 220 mm

- capacity: approx. 250 paper towels
- with mesh basket, capacity: 32 litres
- waste deposited from top

WP 5110



Combination paper towel dispenser and waste bin
298 x 1198 x 220 mm

- capacity: approx. 500 paper towels
- with mesh basket, capacity: 32 litres
- waste deposited from top

WP 5120



Combination paper towel dispenser and waste bin
298 x 1198 x 220 mm

- capacity: approx. 500 paper towels
- with mesh basket, capacity: 32 litres
- waste deposited from top

WP 5410

Combination paper towel, soap dispenser and waste bin*
448 x 1198 x 220 mm

- capacity: approx. 500 paper towels
- soap dispenser with single-handed, drip-free soap pump
- capacity: 950 ml soap bottle
- with mesh basket, capacity: approx. 48 litres

WP 5420

Combination paper towel, soap dispenser and waste bin*
448 x 1198 x 220 mm

- capacity: approx. 500 paper towels
- soap dispenser with single-handed, drip-free soap pump
- capacity: 950 ml soap bottle
- with mesh basket, capacity: approx. 48 litres

WP 5450

Combination electronic touch-free paper roll dispenser and waste bin
448 x 1348 x 220 mm

- capacity: 1 paper roll
- contact-free, capacitive sensor technology
- residual roll function
- paper length and idle time adjustable
- with mesh basket, capacity: approx. 48 litres

WP 5710

Combination paper towel, soap dispenser and waste bin*
448 x 1348 x 320 mm

- capacity: approx. 750 paper towels
- soap dispenser with single-handed, drip-free soap pump
- capacity: 950 ml soap bottle
- with mesh basket, capacity: approx. 72 litres

WP 5720

Combination paper towel, soap dispenser and waste bin*
448 x 1348 x 320 mm

- capacity: approx. 750 paper towels
- soap dispenser with single-handed, drip-free soap pump
- capacity: 950 ml soap bottle
- with mesh basket, capacity: approx. 72 litres

* Also available upon request with sensor-liquid soap dispenser or foam soap dispenser

Nappy changer for flush-mounting

- available in satin finish
- available in horizontal and vertical versions
- table surface molded made of grey Polypropylen
- easy to open and to close with assistance from a maintenance free, pneumatic cylinder
- TÜV-certified



WP 2010

WP 2110



Nappy changer
900 x 566 x 135 mm

Nappy changer
530 x 936 x 135 mm

MODELS FOR UNDER-COUNTER MOUNTING





WP 170



Paper towel dispenser
298 x 148 x 310 mm

- capacity: approx. 500 paper towels
- extendable for refilling
- lockable

WP 139



Waste bin
298 x 448 x 310 mm

- capacity: approx. 18 litres
- with mesh basket
- with hinged lid
- lockable



*Assembly example:
Combination of WP 170
and WP 139*

WP 520



**Combination paper towel dispenser
and waste bin**
298 x 596 x 310 mm

- capacity: approx. 500 paper towels
- extendable for refilling
- with mesh basket, capacity: approx. 18 litres
- with hinged lid
- lockable
- optional: Off-floor installation with console

WP 511



**Combination paper towel dispenser
and waste bin**
298 x 645 x 164 mm

- capacity: approx. 250 paper towels
- hinged for refilling
- with mesh basket, capacity: approx. 11 litres
- with hinged lid
- lockable
- optional: Free-standing installation on stainless steel base

**Models for under-counter mounting
Paper towel dispensers,
waste bins,
combinations**

- available in satin and polished finishes
- front operation
- combinable with many Wagner-EWAR models

**WP 165
WP 166**



WP 165 Paper towel dispenser
326 x 173 x 164 mm

WP 166 Paper towel dispenser
(no image)
298 x 148 x 164 mm

- capacity: approx. 250 paper towels
- hinged for refilling
- lockable

**WP 135
WP 136**



WP 136 Swing flap with mounting frame
326 x 173 x 10 mm

WP 135 Swing flap with mounting frame
(no image)
298 x 148 x 10 mm

WP 146-1

Waste disposal frame
148 x 298 x 20 mm

WP 159-1



Waste disposal ring
diameter 150 x 20 mm



**Models for under-counter mounting
Waste bins**

- available in satin or polished finishes (not L 188 / L 190)
- waste deposited from top

WP 196

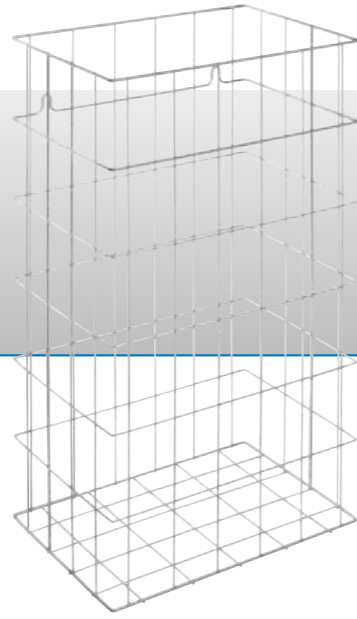

Waste basket, chrome plated
350 x 600 x 250 mm

- capacity: approx. 52,5 l

WP 197

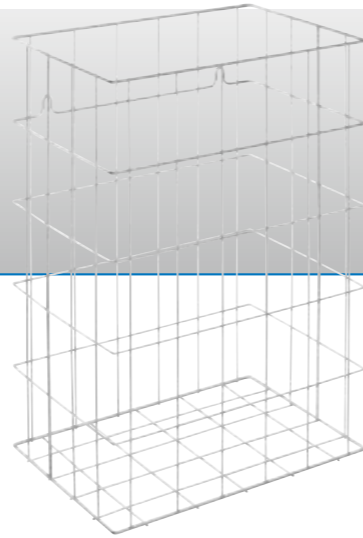

Waste basket, chrome plated
350 x 500 x 250 mm

- capacity: approx. 44 l

WP 198



Waste bin
298 x 450 x 510 mm

- capacity: approx. 43 litres
- with mesh basket
- lockable

L 188

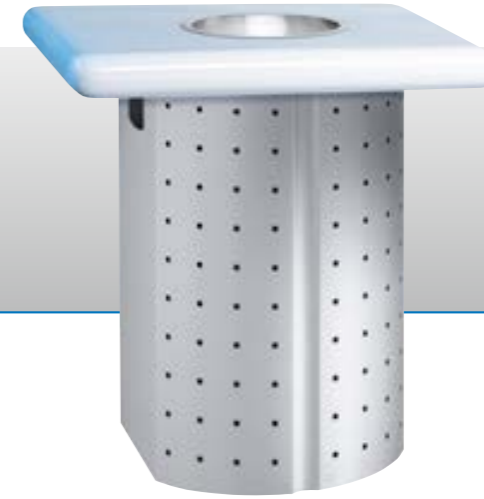

Waste bin
298 x 448 x 297 mm

- capacity: approx. 35 litres
- rounded front, perforated
- with mounting

L 190



Waste bin
298 x 450 x 510 mm

- capacity: approx. 43 litres
- with mesh basket
- perforated conical door
- lockable



WP 199



Siphon cover
diameter 121 x 268 mm

- with fitting springs

WP 188



Waste bin
298 x 448 x 300 mm

- capacity: approx. 40 litres

**Models for under-counter mounting
Paper towel dispensers, waste disposal flaps**

- available in satin or polished finishes
- top operation

WP 117



Paper towel dispenser
200 x 300 x 185 mm

- for building into vanity unit
- capacity: approx. 250 paper towels
- dispenser top fillable through tilting housing flap

WP 154-1



Waste disposal flap
300 x 235 x 30 mm

- for building into vanity unit
- self-closing by counterweight

WP 154



Waste disposal flap
170 x 235 x 30 mm

- for building into vanity unit
- self-closing by counterweight

WP 158-1



Waste disposal flap
170 x 170 x 30 mm

- for building into vanity unit
- self-closing by counterweight



WP 159



Waste disposal ring
diameter 150 x 100 mm

- for building into vanity unit

WP 145



Waste disposal frame
170 x 170 x 100 mm

- for building into vanity unit

Models for mounting behind mirror or in cabinet

- WP 174 and WP 176 for mounting behind fixed mirror refilling from the bottom
- WP 173 and WP 175 for mounting behind a cabinet door refilling from the top

WP 174
WP 174-1
WP 174-2
WP 174-5



Soap dispenser behind mirror

- dispenser can be pulled out underneath for refilling
- single-handed operation, drip-free soap pump
- capacity:
 - WP 174: 200 ml fixed soap tank
 - WP 174-1: 700 ml fixed soap tank
 - WP 174-2: 950 (500) ml soap bottle
 - WP 174-5: 400 ml foam soap concentrate

WP 174e
WP 174e-2



Sensor-soap dispenser behind mirror

- dispenser can be pulled out underneath for refilling
- capacity:
 - WP 174e: 200 ml fixed soap tank
 - WP 174e-2: 950 (500) ml soap bottle (no image)

WP 175



Paper towel dispenser for mounting in cabinet

298 x 298 x 111 mm

- capacity: approx. 500 paper towels

WP 176



Paper towel dispenser behind mirror

298 x 360 x 120 mm

- capacity: approx. 500 paper towels
- dispenser can be pulled out underneath for refilling
- minimum height over vanity unit 160 mm

WP 173
WP 173-1
WP 173-2
WP 173-3
WD 173-5



Soap dispenser for mounting in cabinet

- single-handed operation, drip-free soap pump
- capacity:
 - WP 173: 950 (500) ml soap bottle
 - WP 173-1: 200 ml fixed soap tank (no image)
 - WP 173-2: 700 ml fixed soap tank (no image)
 - WP 173-3: 1100 ml fixed soap tank (no image)
 - WP 173-5: 400 ml foam soap concentrate (no image)

WP 173e
WP 173e-1



Sensor-soap dispenser for mounting in cabinet

- drip-free soap pump
- capacity:
 - WP 173e: 950 (500) ml soap bottle
 - WP 173e-1: 200 ml fixed soap tank (no image)

CONSUMABLES

Liquid soap dispensers for disposable soap bottles, foam soap dispensers, paper towels dispensers and combinations are always initially filled with liquid soap or one package of paper towels. With the P-Line only foam soap dispensers are delivered with a first fill.



Name	ID number	Name	ID number
Paper towels, Ewadry-premium two-play, 100% cellulose, white, V-folding, 25 x 23 cm. • 40 packages of 150 paper towels/box	923 501	Sanitary bags for WP 156 + WP 177 • 10 packs of 30 bags • 50 packs of 30 bags	923 528 923 529
Liquid soap Ewaderm soft Biologically degradable, environmentally friendly, dermatologically and allergologically tested. • 12 bottles of 500 ml/box • 12 bottles of 950 ml/box	950 594 950 595	Fabric standbags for waste bins WP 182, Size 240 x 280 x 575 mm • 3 pieces	929 000
Liquid soap Ewaderm sept Biologically degradable, environmentally friendly, dermatologically and allergologically tested, excellent reducing effect against bacteria, fungi and yeast infections. With high quality, moisturising and skincaring substances. Odorless, pH value lightly acidic • 12 bottles of 950 ml/box	921 685	for waste bins PP/WP 126, Size 160 x 280 x 425 mm • 3 pieces	922 920
Closing cap for 950 ml soap bottle, for refilling disposable bottles, 10 pieces	950 597	for waste bins PP 151 + WP 183 Size 235 x 380 x 590 mm • 3 pieces	922 921
Liquid soap Ewaderm soft, 10 litre bundle	921 920	for waste bins PP/WP 152, Size 180 x 280 x 575 mm • 3 pieces	922 922
Liquid soap Ewaderm sept, 10 litre bundle	923 433	EWAR-Stainless steel care cleaner 500 ml bottle with spray nozzle	950 521
Foam soap concentrate for foam dispensers, • 12 bottles of 400 ml/box	950 599		

www.wagner-ewar.de



WAGNER
EWAR

Ernst Wagner GmbH & Co. KG
Sanitary Fittings in Stainless Steel
Ernst-Abbe-Straße 21
D-72770 Reutlingen
Phone +49 (71 21) 5 15 39-0
Fax +49 (71 21) 5 15 39-20
info@wagner-ewar.de
www.wagner-ewar.de

EWAR 08/14 www.zetb.de 065_098